

the thrifty . . . all purpose . . .
MORRIS MINI-TRAVELLER

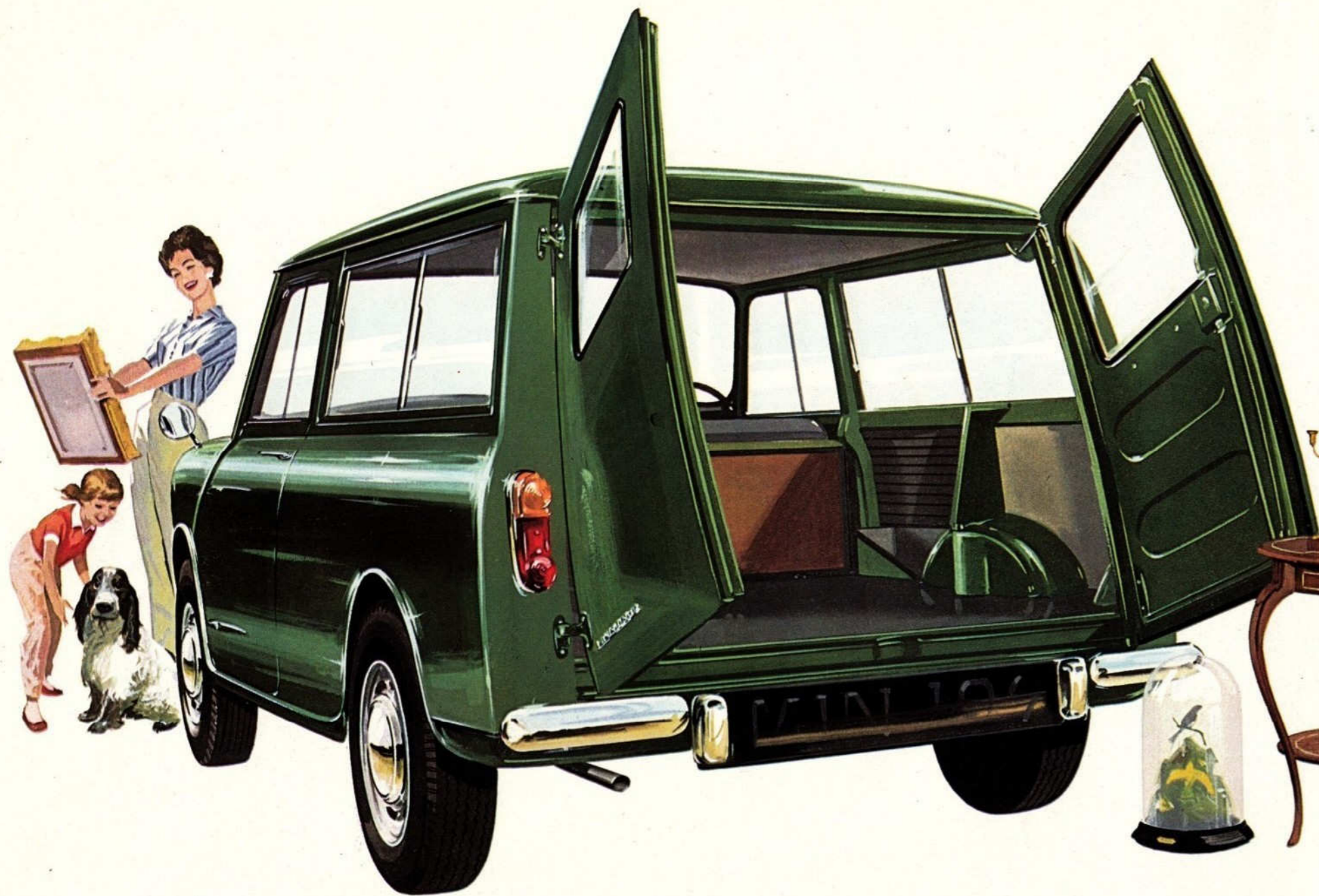



HERE'S THE ONE CAR that can cope with the needs of a three-car family all by itself.

LOOK! It's a perfect town car. Nimble in traffic. Parkable in a space the size of a bedsheet. (Overall length 10' 9 $\frac{1}{2}$ ", turning circle 32' 9"). Fashionable enough to be seen in anywhere. (Check how many famous people own this car.)

LOOK AGAIN! It's a sporty, long-range tourer—a *traveller*. Close kin to the outright Monte-winning Minis, it can cruise a motorway all day, holding to a twisting road like a leach, drink less fuel than a camel and carry a family with *all* their luggage in style (4 seats + 9 cu. ft. baggage capacity, convertible to 2 seats + 35 $\frac{1}{2}$ cu. ft. max. baggage capacity, any time you like).





MinipassionMini.com



**Business or pleasure . . .
. . . play it any way you like.**

Your Morris Mini-Traveller is a sleek little work horse with a giant-size capacity for long hours, heavy loads and rough usage.

It is also a car for pure pleasure. When night falls or the first morning of the holiday dawns, just swing open the big rear doors, unload the goods of your trade, flip the rear seat into position, step aboard, relax, head where you're going and have fun.



Don't count your piglets . . . just pile them into your Mini. The Power-Pack transverse engine-transmission

unit is way up front—as far out of the way as you can get. Every other place

in your Traveller you look there's room—nothing else except nicely placed controls and four cushy seats.

So, however many piglets you have, just litter them all over the rear compartment. The tough leathercloth upholstery

won't mind. The smooth, 5-layer baked-on interior paintwork won't mind. *They* won't mind—they'll be

floating on 4-wheel rubber-and-air independent suspension (a fabulous

rarity even in champagne and caviar surtax-class Grand Tourers).

P.S. 4 frightened piglets can hide in the 2 deep door buckets a Traveller driver usually reserves for the bits

and pieces he wants on voyage.

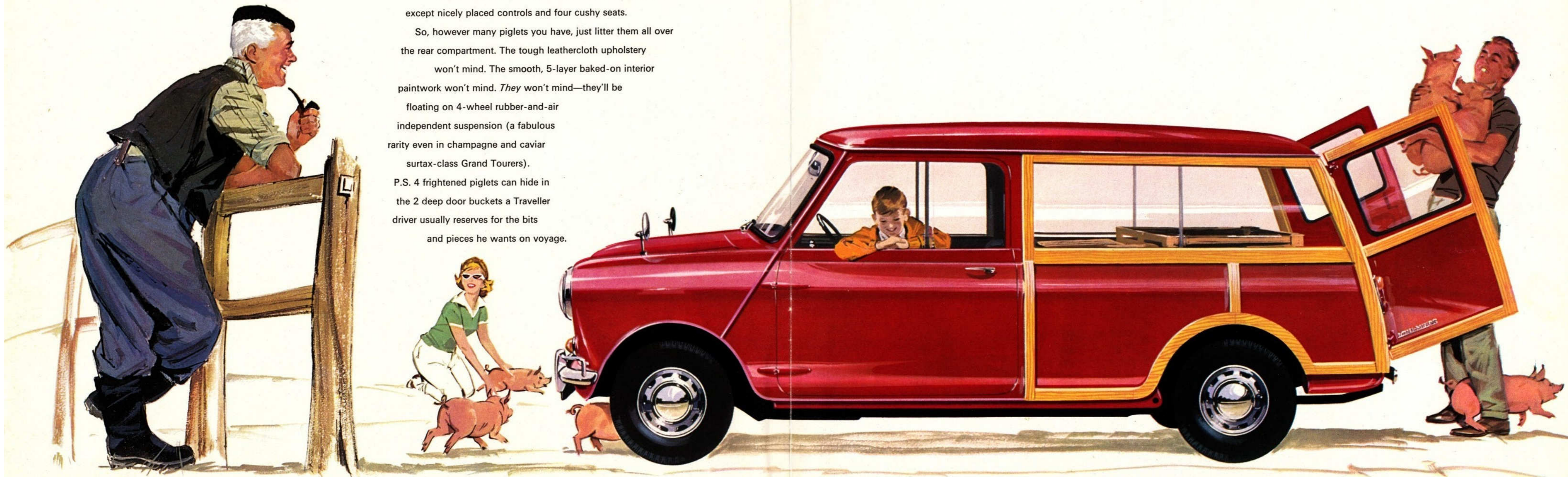

4 WHEEL INDEPENDENT RUBBER SUSPENSION

You'll wonder where all the bumps have gone—with the Mini-Traveller's advanced system of rubber suspension. Harshness and body vibration have just disappeared—independent suspension for each wheel irons out the roughest road.

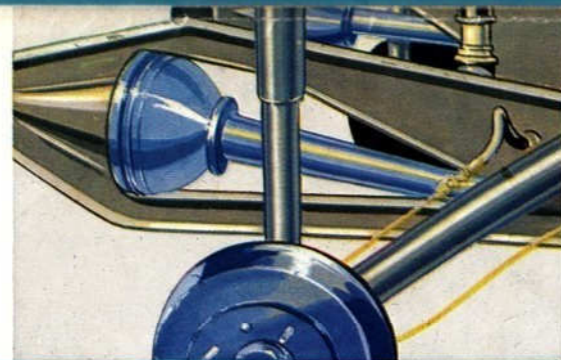

EASIER HANDLING AND EASIER PARKING

When you get behind the wheel of a Mini-Traveller you'll soon find how easy it is to handle. Compact size, wide all-round visibility, and easily accessible controls make it a driver's delight. And it nips through traffic, parks where larger vehicles wouldn't have a hope.



LOADS MORE SPACE

Because the engine goes across the frame there's unbelievable roominess inside the Mini-Traveller. You'll find plenty of space for your luggage—and roomy comfort for four big adults, too. It's amazing how the Mini-Traveller does it!



MORE STOWAGE ROOM

Fold the back seat forward and there's yet more generous space for baggage—sporting and holiday. There's so much useful space in the Mini-Traveller. And everything you put in is so easy to get at, through the double-opening doors at the back.



THE FIRST THING

ABOUT YOUR MORRIS MINI-TRAVELLER

is that it's lovable. No other car has aroused so much genuine and lasting affection in the people who own it.

But a Mini never gets pampered. Kid glove treatment is unnecessary. The body is solidly engineered from 20 gauge steel. 5 layers of paint are baked and boned onto it to stay there and stay looking good in any climate. The seats and interior trim wipe clean.

The engine/transmission unit is the simplest plant in the world to keep serviced (and there are 11,000 BMC service stations across the world to look after it for you).

Wherever you take your Mini Traveller, whatever purpose you use it for, you'll be travelling with a friend you can rely on.

BMC World's Largest Producers of Front Wheel-Powered vehicles. Over a million sold.

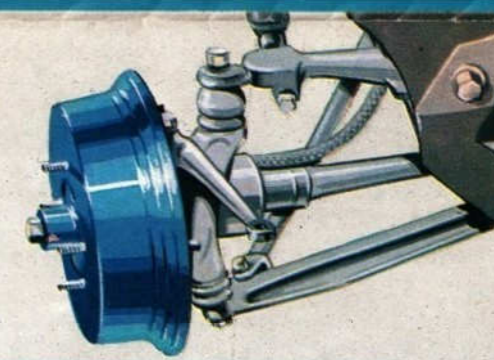

FRONT WHEEL DRIVE

In the Mini-Traveller the drive is at the front—giving you a wonderful sense of mastery and control. And it's another great space-saver, doing away with the need for a long transmission shaft and rear axle 'hump'.



EASY ACCESSIBILITY

There's a wide, deep pocket on each door, a big shelf the full width of the fascia—space for all those odds and ends.

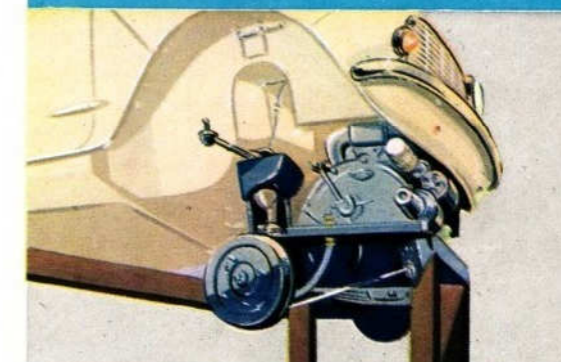

UNIQUE POWER PACK

This is the stout heart of the Mini-Traveller—all the major mechanical parts in one amazingly compact unit. Engine, clutch and gears, differential and transmission are actually combined in the unique 'Power Pack' that takes up only 18 inches (46 cm.) of the Traveller's length.



COMPACTNESS OF DESIGN

It's an engineering miracle, the way Morris have built so much room into such a compact shape. The Mini-Traveller is less than 11 feet (3.4 m.) long—and there isn't an inch wasted. And note particularly the way that the wheels are deliberately positioned at the four corners to provide maximum stability.

There's room for everything . . .

Room for a lively family! Room for all their everyday extras! Room for their special holiday luggage—and then room to spare! Open those wide rear doors. In go the golf clubs, the week-end cases, and the picnic basket. How about junior's bike? No trouble at all—and by folding the rear seats forward you can have more room still whenever you want it. The Traveller is also available without wooden battens. You'll wonder how the Mini-Traveller does it.

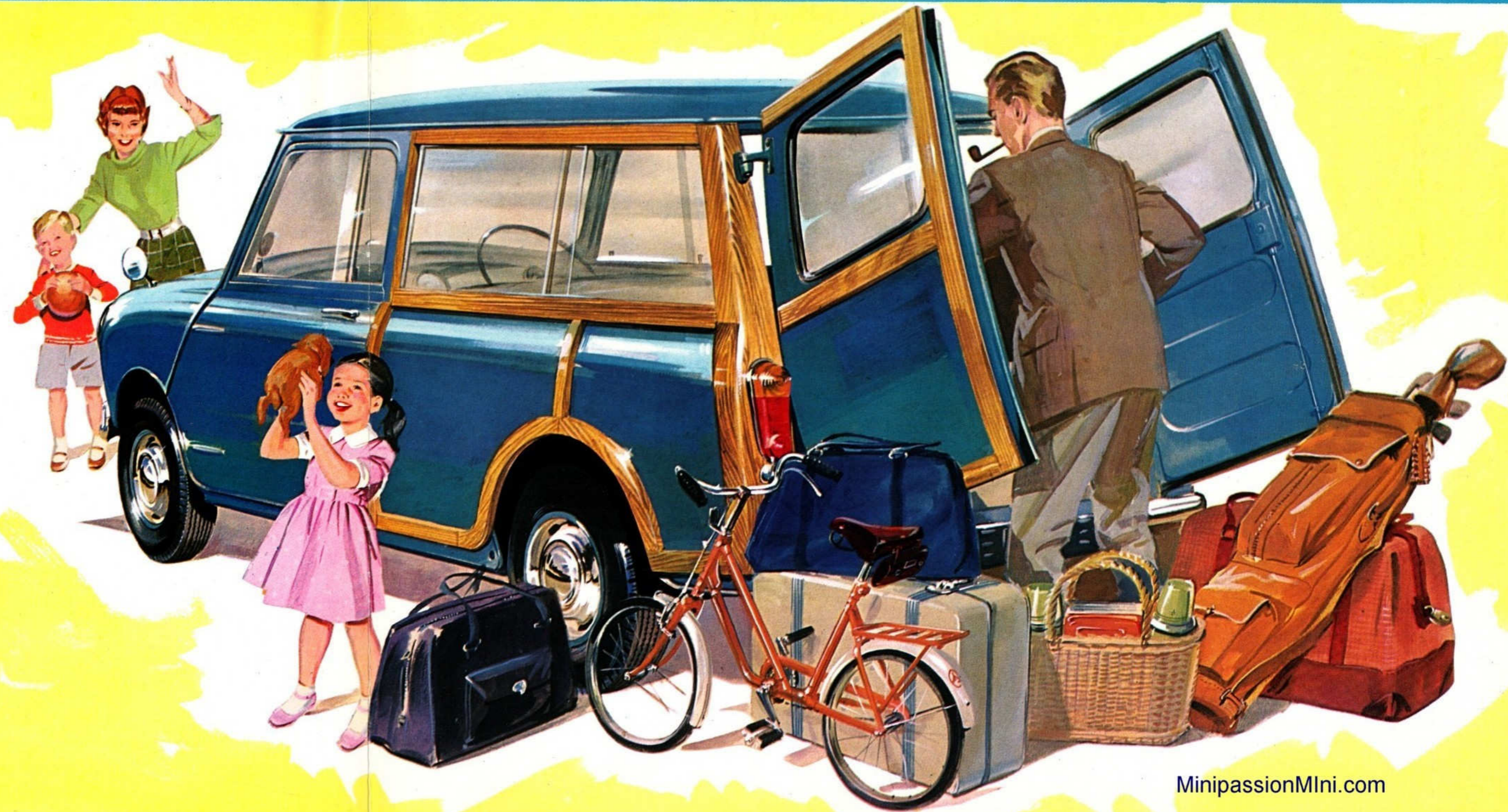

SPECIFICATION

ENGINE: Four-cylinder overhead-valve; bore 2.48 in. (63 mm.), stroke 2.69 in. (68.26 mm.), cubic capacity 51.79 cu. in. (848 c.c.), compression ratio 8.3 : 1. Full-flow renewable-element external oil filter. Three-bearing crankshaft; main and connecting rod bearings with renewable liners. Aluminium-alloy pistons.

Cooling: Water-cooled, pressurized system, impeller pump and fan-assisted. Thermostatic heat control. Capacity of system 6½ pints (3.55 litres, 7.5 U.S. pints) (5½ pints [2.98 litres, 6.3 U.S. pints] less heater).

Ignition: Battery and coil ignition. Automatic advance and retard with centrifugal and vacuum control.

Carburation: Semi-down draught S.U. HS2-type carburettor fed by rear-mounted electric fuel pump. Air cleaner and silencer. Fuel tank capacity 6 Imperial gallons (27 litres, 7½ U.S. gallons).

TRANSMISSION: Hydraulically actuated single dry plate clutch.

GEARBOX: Four-speed (balk ring synchromesh on second, third, and top gears). Overall ratios—first 13:657, second 8:176, third 5:317, fourth 3:765, reverse 13:657 : 1. Final drive ratio 3:765 : 1. Transversely mounted power unit with mainshaft in constant mesh with differential assembly mounted on side of transmission casing. Drive transmitted by universal joints to the front road wheels. Central floor gear change. Transmission casing and oil sump combined below engine crankcase.

BRAKES: Lockheed hydraulic brakes. Operated by pendent-type pedal. Front and rear—drum type 7 in. (17.8 cm.) diameter with two leading shoes and pressure limiting valve. Total lining area 67.5 sq. in. (433.53 cm.²). Foot brake on all 4 wheels; hand brake on rear wheels only. Simple shoe adjustments—rear and hand brake adjusted simultaneously.

WHEELS: Ventilated disc-type wheels with 4-stud fixing (3.50B × 10). Stainless steel wheel embellishers. Spare wheel housed below detachable floor behind rear seat.

TYRES: Dunlop 5-20—10 tubeless. Whitewall tyres optional. Weathermaster tyres optional on front wheels.

STEERING: Rack and pinion with direct coupling to rack and steering-arms. Steering-arms bolted to swivel hub. Two-spoke steering-wheel. 15½ in. diameter (39.4 cm.) with central horn-push. Turning circle 32 ft. 9 in. (9.983 m.). Track—front 3 ft. 11⅞ in. (1.205 m.); rear 3 ft. 9⅞ in. (1.164 m.). Available left- or right-hand drive according to market.

SUSPENSION: Front—independent by rubber cone spring units; upper and lower suspension arms attached to swivel pin hubs by ball joints. Rear—independent by rubber cone spring units and radius arms. Hydraulic telescopic dampers front and rear.

BODY: Special body of station wagon type (wooden battens optional). Adjustable bucket-type front seats which tilt forward to give easy access to rear seat. Folding rear seat which provides comfortable seating for 2 passengers or folds forward to form an extended floor for extra luggage accommodation. Wide double doors in the rear may be retained in the open position with automatic check straps which prevent the doors from opening beyond the width of the vehicle. All doors may be locked.

ELECTRICAL EQUIPMENT: High-output dynamo with compensated voltage control; 12-volt 34-amp.-hr. battery (at 20-hr. rate); double dipping headlamps, foot dipping switch; parking lights; twin stop and tail lamps; flashing direction indicators with automatic cancelling; rear number-plate lamps; instrument lighting; courtesy interior light; ignition, main beam, and flashing indicator warning lights; dual-arm windscreen wiper; electric horn.

INSTRUMENTS: Speedometer with total distance recorder calibrated in tenths of a mile; fuel gauge; oil pressure and water temperature gauges.

CONTROLS: Mixture; starter; heater; windscreen wiper; lighting; parcel shelf lamp; windscreen washer.

VENTILATION: Double sliding windows in each door; fresh-air heating/demister unit (Home only—optional Export).

GENERAL EQUIPMENT: Safety glass all round; large curved windscreen; twin wing mirrors; pile carpet floor covering with underfelt; front over-riders; ashtray in windscreen rail; companion-boxes with ashtrays each side of rear seat; leathercloth upholstery with foam-rubber seat cushions; 2 crushable sun visors; parcel shelf in front compartment and useful door pockets; windscreen washers; bright plastic sill finishers and windscreen surround; provision for fitting Smiths Radiomobile radio and B.M.C. seat belts.

OPTIONAL EXTRAS: Heater and demister, recirculatory or fresh-air type; Whitewall tyres; Weathermaster tyres for front wheels (Export only).

SELECTED ACCESSORIES: (available from your Distributor or Dealer): Wing Mirrors; Fog and Driving Lamps; Hand Tools; Car-valeting items; Seat Belts; Seat Covers; Touch-up Paint; Exhaust Deflectors; Reversing Lamps; Door Pocket Ashtrays; Anti-mist Panels; Sun Visors (green perspex).

COLOURS:

Body	Upholstery
Fiesta Yellow	Powder Blue
Tartan Red	Tartan Red
Surf Blue	Powder Blue
Tweed Grey	Blue-grey
Old English White	Tartan Red
Almond Green	Porcelain Green

The issue of this folder does not constitute an offer, and the right is reserved to alter prices and/or specifications at any time without notice. Sales are made subject to and with the benefit of the Morris Motors Limited or Nuffield Exports Limited Conditions of Sale and Warranty, copies of which are available from Distributors and Dealers. For prices see separate list.

MORRIS MOTORS LIMITED

(Sales Division)

BOX 41 G.P.O., LONGBRIDGE, BIRMINGHAM

OVERSEAS BUSINESS

NUFFIELD EXPORTS LIMITED

Proprietors: MORRIS MOTORS LIMITED

COWLEY, OXFORD, ENGLAND



MinipassionMini.com

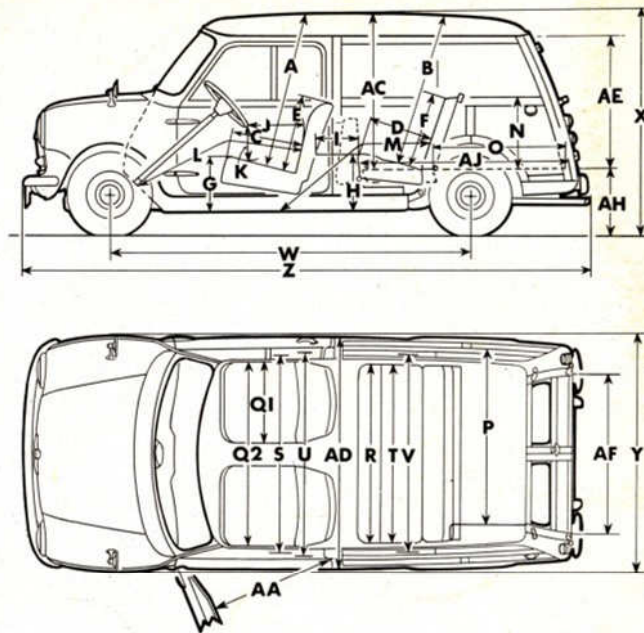

LEADING DIMENSIONS AND WEIGHTS

		English	Metric
Front seat cushion to roof	A	3 ft. 2 in.	97 cm.
Rear seat cushion to roof	B	2 ft. 11 in.	89 cm.
Front cushion depth	C	1 ft. 6 in.	45 cm.
Rear cushion depth	D	1 ft. 5 in.	43 cm.
Front seat height	E	1 ft. 7 in.	48 cm.
Rear seat height	F	1 ft. 5 in.	43 cm.
Height of front cushion	G	1 ft. 1½ in.	34 cm.
Height of rear cushion	H	1 ft. 2 in.	36 cm.
Back of front seat to front of rear cushion	I	{ max. 11½ in. min. 7½ in.	{ 29 cm. 18 cm.
Steering-wheel to rear of front seat	J	{ max. 1 ft. 4½ in. min. 1 ft. 0½ in.	{ 42 cm. 32 cm.
Steering-wheel to cushion	K	6½ in.	16 cm.
Leg room—front	L	{ max. 3 ft. 7½ in. min. 3 ft. 5 in.	{ 1.10 m. 1.04 m.
Leg room—rear	M	{ max. 3 ft. 9 in. min. 3 ft. 3 in.	{ 1.14 m. 99 cm.
Luggage boot height	N(max.)	1 ft. 4 in.	41 cm.
Luggage boot depth	O(max.)	2 ft. 5½ in.	75 cm.
Luggage boot width	P(max.)	3 ft. 5 in.	1.04 m.
Width of front bucket seats	Q1	1 ft. 8½ in.	52 cm.
Overall width of front seats	Q2	3 ft. 7½ in.	1.10 m.
Width of rear cushion	R	3 ft. 5 in.	1.04 m.
Max. front seating width at cushion level	S	3 ft. 9½ in.	1.16 m.
Max. rear seating width at cushion level	T	3 ft. 5 in.	1.04 m.
Width over front seat at shoulder height	U	3 ft. 10 in.	1.17 m.
Width over rear seat at shoulder height	V	3 ft. 9½ in.	1.16 m.
Wheelbase	W	7 ft. 0½ in.	2.14 m.
Overall height	X	4 ft. 5½ in.	1.36 m.
Overall width	Y	4 ft. 7½ in.	1.41 m.
Overall length	Z	10 ft. 9½ in.	3.30 m.
Door entry width—front	AA	2 ft. 8 in.	81 cm.
Rear floor to roof	AC	2 ft. 10½ in.	88 cm.
Max. inside width	AD	4 ft. 4½ in.	1.33 m.
Rear door height	AE	2 ft. 6 in.	76 cm.
Rear door width	AF	3 ft. 1 in.	94 cm.
Height rear floor to ground	AH	1 ft. 6 in.	45 cm.
Max. depth of rear floor with rear seats in folded position	AJ	3 ft. 11½ in.	1.21 cm.
Unladen weight (approx.)		13 cwt.	660 kg.